

CertainTeed

WeatherBoards™

Fiber Cement Siding

2012 Product Catalog

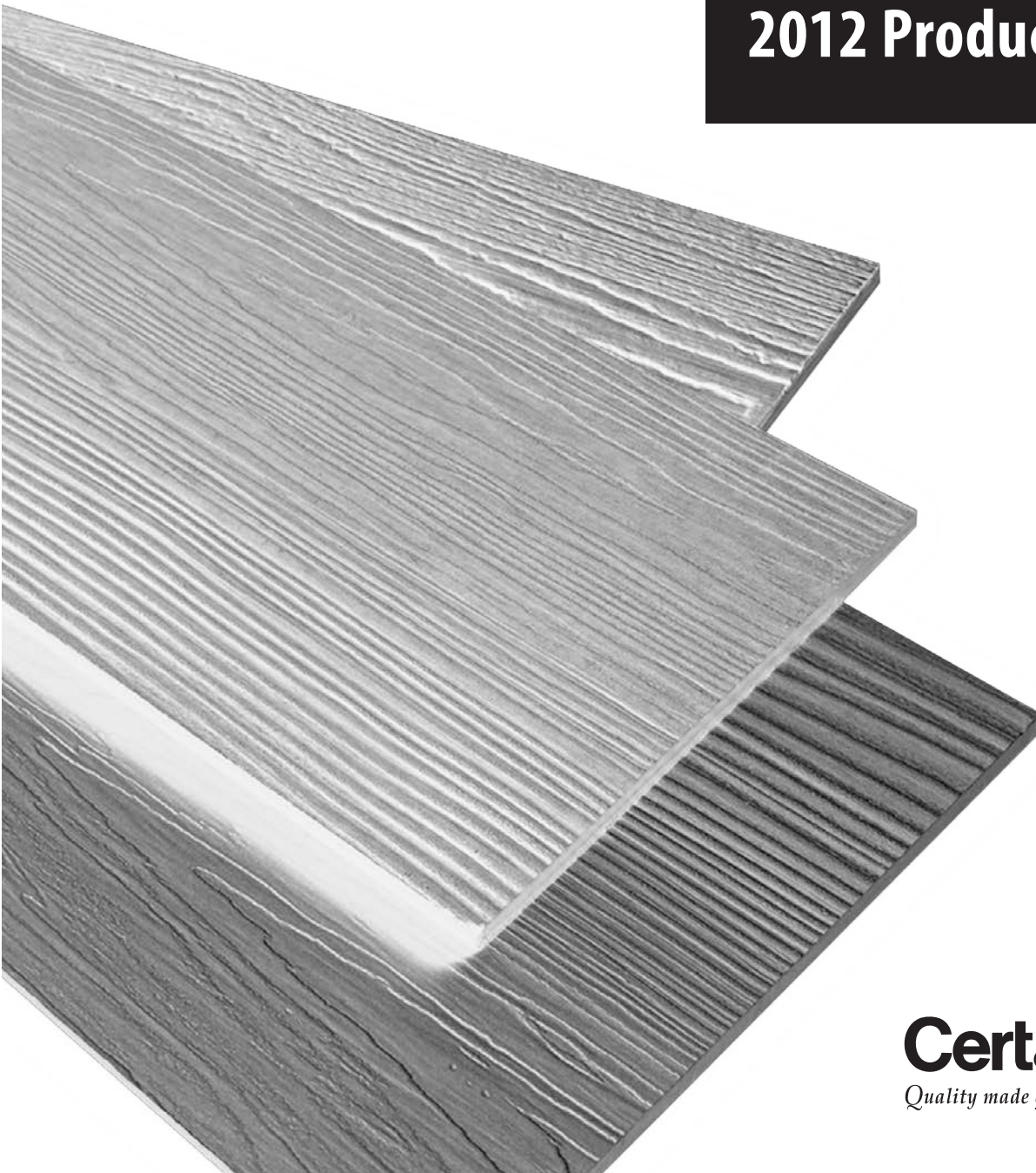

CertainTeed 
Quality made certain. Satisfaction guaranteed.™

WeatherBoards™ Product Portfolio At-a-Glance

CertainTeed WeatherBoards™ Fiber Cement Siding

SOLID COLORS

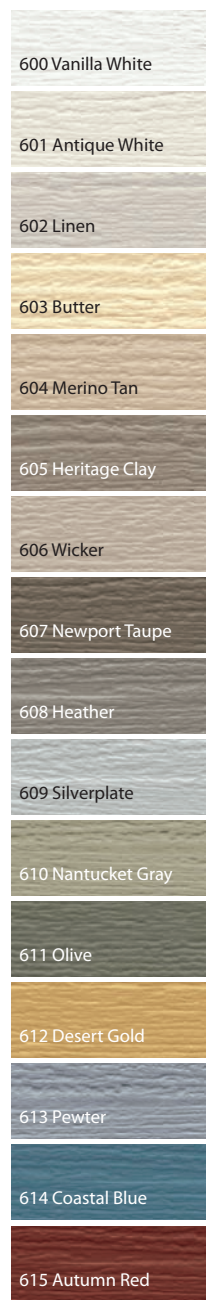

	FIBERTECT® FINISH		COLORMAX® FINISHING SYSTEM – ■ SOLID COLORS and ● STAINS								
	FULL UNIT		FULL UNIT			HALF UNIT			MICRO UNIT		
	Pieces/Unit	Sq. Cov./Unit	STAIN SOLID	Pieces/Unit	Sq. Cov./Unit	STAIN SOLID	Pieces/Unit	Sq. Cov./Unit	STAIN SOLID	Pieces/Unit	Sq. Cov./Unit
SHAPES											
8-1/4" Perfection Shingles (7" Exposure)	165	11.6	●	160	11.2				●	36	2.5
Random Square Straight Edge (5" Exposure)	120	2	■	120	2				■	60	1.0
Random Square Straight Edge (7" Exposure)	129	3	●	129	3				●	45	1.1
Random Square Staggered Edge (7" Exposure)	129	3	●	129	3				●	45	1.1
Individual Shakes (8" Exposure)	990	5									
Half-Rounds (7" Exposure)	129	3	■	129	3				■	45	1.1
Octagons (7" Exposure)	129	3	■	129	3				■	45	1.1
LAP SIDING											
5-1/4" Cedar	336	13.4	■	320	12.8	■	160	6.4	■	64	2.6
6-1/4" Cedar	294	14.7	●	280	14	●	140	7	●	48	2.4
7-1/4" Cedar	252	15.1	●	240	14.4	●	120	7.2	●	36	2.2
8-1/4" Cedar	225	15.8	●	220	15.4	●	100	7	●	36	2.5
9-1/4" Cedar	200	16									
12" Cedar	152	16.3									
5-1/4" Smooth	336	13.4	■	320	12.8	■	160	6.4	■	64	2.6
6-1/4" Smooth	294	14.7	■	280	14	■	140	7	■	48	2.4
7-1/4" Smooth	252	15.1	■	240	14.4	■	120	7.2	■	36	2.2
8-1/4" Smooth	225	15.8	■	220	15.4	■	100	7	■	36	2.5
9-1/4" Smooth	200	16									
12" Smooth	152	16.3									
7-1/2" Smooth Beaded	252	15.8	■	240	15	■	120	7.5	■	36	2.3
7-1/2" Textured Beaded	252	15.8	■	240	15	■	120	7.5	■	36	2.3
8-1/4" Textured Dutchlap	225	15.8	■	220	15.4	■	100	7	■	36	2.5
VERTICAL SIDING											
4' x 8' Cedar No Groove	50	16	■	50	16	■	25	8			
4' x 9' Cedar No Groove	50	18									
4' x 10' Cedar No Groove	50	20	■	50	20	■	25	10			
4' x 8' Cedar 8" Groove	50	16	■	50	16	■	25	8			
4' x 9' Cedar 8" Groove	50	18									
4' x 10' Cedar 8" Groove	50	20	■	50	20	■	25	10			
4' x 8' Smooth	50	16	■	50	16	■	25	8			
4' x 9' Smooth	50	18									
4' x 10' Smooth	50	20	■	50	20	■	25	10			
4' x 8' Stucco	50	16	■	50	16	■	25	8			
4' x 9' Stucco	50	18									
4' x 10' Stucco	50	20	■	50	20	■	25	10			
PORCH CEILING PANEL											
4' x 8' Cedar	50	16	■	50	16				■	12	3.8
4' x 8' Smooth	50	16	■	50	16				■	12	3.8

STAINS



Not all profiles and sizes are available in solid colors or stains.
Colors shown are as accurate as printing methods permit.

	FIBERTECT® FINISH		COLORMAX® FINISHING SYSTEM – ■ SOLID COLORS and ● STAINS									
	FULL UNIT		FULL UNIT			HALF UNIT			MICRO UNIT			
	Pieces/Unit	Sq. Cov./Unit	STAIN SOLID	Pieces/Unit	Sq. Cov./Unit	STAIN SOLID	Pieces/Unit	Sq. Cov./Unit	STAIN SOLID	Pieces/Unit	Sq. Cov./Unit	
SOFFIT												
12" Cedar	188	22.6	●	188	22.6				●	16	1.9	
12" Cedar Ventilated/Perforated	188	22.6	●	188	22.6				●	16	1.9	
16" Cedar	141	22.6	●	141	22.6				●	14	2.2	
16" Cedar Ventilated/Perforated	141	22.6	●	141	22.6				●	14	2.2	
24" Cedar	94	22.6	●	94	22.6				●	12	2.9	
24" Cedar Ventilated/Perforated	94	22.6	●	94	22.6				●	12	2.9	
12" Smooth	188	22.6	■	188	22.6				■	16	1.9	
12" Smooth Ventilated/Perforated	188	22.6	■	188	22.6				■	16	1.9	
16" Smooth	141	22.6	■	141	22.6				■	14	2.2	
16" Smooth Ventilated/Perforated	141	22.6	■	141	22.6				■	14	2.2	
24" Smooth	94	22.6	■	94	22.6				■	12	2.9	
24" Smooth Ventilated/Perforated	94	22.6	■	94	22.6				■	12	2.9	
	Pieces/Unit	Lineal Ft/Unit	STAIN SOLID	Pieces/Unit	Lineal Ft/Unit	STAIN SOLID	Pieces/Unit	Lineal Ft/Unit	STAIN SOLID	Pieces/Unit	Lineal Ft/Unit	
TRIM*												
3-1/2" – 7/16" Trim/Fascia	390	4,680										
5-1/2" – 7/16" Trim/Fascia	248	2,976										
7-1/4" – 7/16" Trim/Fascia	186	2,232										
9-1/4" – 7/16" Trim/Fascia	145	1,740										
11-1/4" – 7/16" Trim/Fascia	120	1,440										
2" – 4/4 Trim*	506	6,072	■	462	5,544				■	18	216	
3" – 4/4 Trim*	352	4,224	■	330	3,960				■	18	216	
4" – 4/4 Trim*	250	3,000	■	240	2,880				■	18	216	
6" – 4/4 Trim*	161	1,932	■	147	1,764				■	16	192	
8" – 4/4 Trim*	115	1,380	■	115	1,380				■	15	180	
10" – 4/4 Trim*	96	1,152	■	88	1,056				■	12	144	
12" – 4/4 Trim*	78	936	■	72	864				■	12	144	
3" – 5/4 Trim*	256	3,072	■	192	2,304				■	18	216	
4" – 5/4 Trim*	190	2,280	●	180	2,160				●	18	216	
5" – 5/4 Trim*	144	1,728	■	144	1,728				■	15	180	
6" – 5/4 Trim*	119	1,428	●	112	1,344				●	16	192	
8" – 5/4 Trim*	90	1,080	■	85	1,020				■	15	180	
10" – 5/4 Trim*	68	816	■	68	816				■	12	144	
12" – 5/4 Trim*	57	684	■	54	648				■	12	144	
NATURAL WHITE												
					Mixed Pallet							
	CertaPak™ Pieces/Unit		Pieces/Full Unit		CertaPak™ Pieces/Unit		Pieces/Full Unit		CertaPak™ Pieces/Unit		Pieces/Full Unit	
FINISHING TOUCHES												
1" x 6" Restoration Millwork® Skirtboard+	4	64		4	32							
1" x 8" Restoration Millwork® Skirtboard+	2	48		2	24							
5/4 x 6" Restoration Millwork® Skirtboard+	4	64		4	32							
5/4 x 8" Restoration Millwork® Skirtboard+	2	48		2	24							
	Pieces/Unit	Sq. Cov./Unit										
UNDERLAYMENT/BACKERBOARD (unprimed)												
3' x 5' Underlayment	85	12.8										
4' x 4' Underlayment	85	13.6										
4' x 8' Underlayment	50	16										
3' x 5' Backerboard	50	7.5										

* 4/4 and 5/4 trim:
– Made expressly for CertainTeed by Plycem®
– Wood Grain/Smooth reversible when primed.
– Stains are available on Wood Grain side only.

+ DualStart™ Wood Grain/Smooth

Shapes

PERFECTION SHINGLES								
Diagram	Sizes	FiberTect® Product Codes	Pieces/ Unit	Sq. Ft./ Unit	Sq. Cov./ Unit	Pieces/ Sq. Cov.	Lbs/ Unit†	Units/ Truck*
	8-1/4" X 12' (7" Exposure) 7/16" thick	10281/000	165	1,361	11.6	14.5+	4,582	10
RANDOM SQUARE STRAIGHT EDGE								
	12" x 48" (5" Exposure)	10326/000	120	480	2	60	1,260	38
	16" x 48" (7" Exposure) 5/16" thick	10329/000	129	688	3	43	1,780	27
RANDOM SQUARE STAGGERED EDGE								
	16" x 48" (7" Exposure) 5/16" thick	10330/000	129	688	3	43	1,780	27

Shapes

INDIVIDUAL SHAKES								
Diagram	Sizes	FiberTect® Product Codes	Pieces/ Unit	Sq. Ft./ Unit	Sq. Cov./ Unit	Pieces/ Sq. Cov.	Lbs/ Unit†	Units/ Truck*
	Full Unit contains: 6-1/4" x 18" (330 pcs/unit) 8-1/4" x 18" (330 pcs/unit) 12" x 18" (330 pcs/unit) (8" Exposure) 1/4" thick	10275/000	990	1,093	5	198	2,237	20
HALF-ROUNDS								
	16" x 48" (7" Exposure) 5/16" thick	10331/000	129	688	3	43	1,780	27
OCTAGONS								
	16" x 48" (7" Exposure) 5/16" thick	10337/000	129	688	3	43	1,780	27

* Product weight per truck is limited to approximately 47,000 pounds. Product can be mixed to fill truck, provided weight does not exceed limit.

† Lbs/Unit is approximate.

+ Rounded up to the nearest half-piece.

CertainTeed Product Codes for Ordering

The Finish, Style, Size and Color of a product is represented with an 8 digit Code System. Choose Product Code from the chart above.

Finish Code

10-FiberTect® Primer/Sealer

Product Code

Style, Size and Texture



Color Code

FiberTect® Primer/Sealer Code is 000

Lap Siding

CEDAR LAP								
Sizes	FiberTect® Product Codes	Pieces/ Unit	Sq. Ft./ Unit	Sq. Cov./ Unit	Pieces/ Sq. Cov.	Lbs/ Unit†	Units/ Truck*	
5-1/4" x 12'	10063/000	336	1,764	13.4	25	4,510	10	
6-1/4" x 12'	10015/000	294	1,837	14.7	20	4,693	10	
7-1/4" x 12'	10016/000	252	1,827	15.1	17+	4,668	10	
8-1/4" x 12'	10017/000	225	1,856	15.8	14.5+	4,740	10	
9-1/4" x 12'	10018/000	200	1,850	16	12.5	4,725	10	
12" x 12' 5/16" thick	10403/000	152	1,824	16.3	9.5+	4,660	10	

SMOOTH LAP								
Sizes	FiberTect® Product Codes	Pieces/ Unit	Sq. Ft./ Unit	Sq. Cov./ Unit	Pieces/ Sq. Cov.	Lbs/ Unit†	Units/ Truck*	
5-1/4" x 12'	10064/000	336	1,764	13.4	25	4,510	10	
6-1/4" x 12'	10004/000	294	1,837	14.7	20	4,693	10	
7-1/4" x 12'	10005/000	252	1,827	15.1	17+	4,668	10	
8-1/4" x 12'	10074/000	225	1,856	15.8	14.5+	4,740	10	
9-1/4" x 12'	10006/000	200	1,850	16	12.5	4,725	10	
12" x 12' 5/16" thick	10401/000	152	1,824	16.3	9.5+	4,660	10	

SMOOTH BEADED								
Sizes	FiberTect® Product Codes	Pieces/ Unit	Sq. Ft./ Unit	Sq. Cov./ Unit	Pieces/ Sq. Cov.	Lbs/ Unit†	Units/ Truck*	
7-1/2" x 12' 5/16" thick	10021/000	252	1,890	15.8	16	4,825	10	

TEXTURED BEADED								
Sizes	FiberTect® Product Codes	Pieces/ Unit	Sq. Ft./ Unit	Sq. Cov./ Unit	Pieces/ Sq. Cov.	Lbs/ Unit†	Units/ Truck*	
7-1/2" x 12' 5/16" thick	10023/000	252	1,890	15.8	16	4,825	10	

TEXTURED DUTCHLAP								
Sizes	FiberTect® Product Codes	Pieces/ Unit	Sq. Ft./ Unit	Sq. Cov./ Unit	Pieces/ Sq. Cov.	Lbs/ Unit†	Units/ Truck*	
8-1/4" x 12' 5/16" thick	10025/000	225	1,856	15.8	14.5+	4,740	10	

* Product weight per truck is limited to approximately 47,000 pounds. Product can be mixed to fill truck, provided weight does not exceed limit.
 † Lbs/Unit is approximate.
 + Rounded up to the nearest half-piece.

Vertical Siding

CEDAR NO GROOVE								
Sizes	FiberTect® Product Codes	Pieces/ Unit	Sq. Ft./ Unit	Sq. Cov./ Unit	Pieces/ Sq. Cov.	Lbs/ Unit†	Units/ Truck*	
4' x 8'	10041/000	50	1,600	16	3.1	4,100	11	
4' x 9'	10042/000	50	1,800	18	2.8	4,600	10	
4' x 10' 5/16" thick	10043/000	50	2,000	20	2.5	5,100	9	

CEDAR 8" GROOVE								
Sizes	FiberTect® Product Codes	Pieces/ Unit	Sq. Ft./ Unit	Sq. Cov./ Unit	Pieces/ Sq. Cov.	Lbs/ Unit†	Units/ Truck*	
4' x 8'	10035/000	50	1,600	16	3.1	4,100	11	
4' x 9'	10036/000	50	1,800	18	2.8	4,600	10	
4' x 10' 5/16" thick	10037/000	50	2,000	20	2.5	5,100	9	

SMOOTH								
Sizes	FiberTect® Product Codes	Pieces/ Unit	Sq. Ft./ Unit	Sq. Cov./ Unit	Pieces/ Sq. Cov.	Lbs/ Unit†	Units/ Truck*	
4' x 8'	10029/000	50	1,600	16	3.1	4,100	11	
4' x 9'	10030/000	50	1,800	18	2.8	4,600	10	
4' x 10' 5/16" thick	10031/000	50	2,000	20	2.5	5,100	9	

STUCCO								
Sizes	FiberTect® Product Codes	Pieces/ Unit	Sq. Ft./ Unit	Sq. Cov./ Unit	Pieces/ Sq. Cov.	Lbs/ Unit†	Units/ Truck*	
4' x 8'	10047/000	50	1,600	16	3.1	4,100	11	
4' x 9'	10048/000	50	1,800	18	2.8	4,600	10	
4' x 10' 5/16" thick	10049/000	50	2,000	20	2.5	5,100	9	

CertainTeed Product Codes for Ordering

The Finish, Style, Size and Color of a product is represented with an 8 digit Code System. Choose Product Code from the chart above.

Finish Code

10-FiberTect® Primer/Sealer

Product Code

Style, Size and Texture



Color Code

FiberTect® Primer/Sealer Code is 000

Porch Ceiling Panel

CEDAR								
	Sizes	FiberTect® Product Codes	Pieces/ Unit	Sq. Ft./ Unit	Sq. Cov./ Unit	Pieces/ Sq. Cov.	Lbs/ Unit†	Units/ Truck*
		4' x 8' 1/4" thick	10122/000	50	1,600	16	3.1	3,450

SMOOTH								
	Sizes	FiberTect® Product Codes	Pieces/ Unit	Sq. Ft./ Unit	Sq. Cov./ Unit	Pieces/ Sq. Cov.	Lbs/ Unit†	Units/ Truck*
		4' x 8' 1/4" thick	10121/000	50	1,600	16	3.1	3,450

Soffit

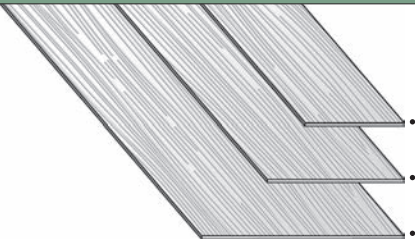
CEDAR								
	Sizes	FiberTect® Product Codes	Pieces/ Unit	Sq. Ft./ Unit	Sq. Cov./ Unit	Pieces/ Sq. Cov.	Lbs/ Unit†	Units/ Truck*
	12" x 12'	10019/000	188	2,256	22.6	8.5+	4,925	10
	16" x 12'	10060/000	141	2,256	22.6	6.5+	4,925	10
	24" x 12' 1/4" thick	10062/000	94	2,256	22.6	4.5+	4,925	10

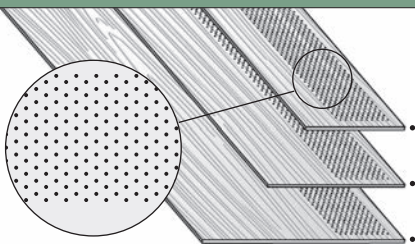
CEDAR VENTILATED/PERFORATED								
	Sizes	FiberTect® Product Codes	Pieces/ Unit	Sq. Ft./ Unit	Sq. Cov./ Unit	Pieces/ Sq. Cov.	Lbs/ Unit†	Units/ Truck*
	12" x 12'	10266/000	188	2,256	22.6	8.5+	4,925	10
	16" x 12'	10268/000	141	2,256	22.6	6.5+	4,925	10
	24" x 12' 1/4" thick	10270/000	94	2,256	22.6	4.5+	4,925	10

Soffit

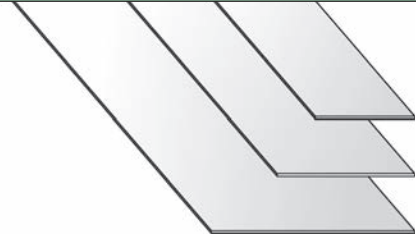
SMOOTH								
	Sizes	FiberTect® Product Codes	Pieces/ Unit	Sq. Ft./ Unit	Sq. Cov./ Unit	Pieces/ Sq. Cov.	Lbs/ Unit†	Units/ Truck*
	12" x 12'	10007/000	188	2,256	22.6	8.5+	4,925	10
	16" x 12'	10335/000	141	2,256	22.6	6.5+	4,925	10

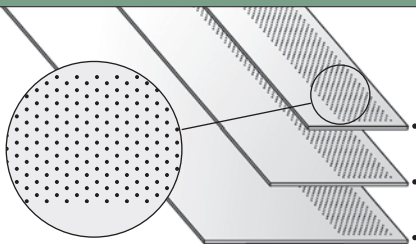
SMOOTH VENTILATED/PERFORATED								
	Sizes	FiberTect® Product Codes	Pieces/ Unit	Sq. Ft./ Unit	Sq. Cov./ Unit	Pieces/ Sq. Cov.	Lbs/ Unit†	Units/ Truck*
	12" x 12'	10267/000	188	2,256	22.6	8.5+	4,925	10
	16" x 12'	10269/000	141	2,256	22.6	6.5+	4,925	10

* Product weight per truck is limited to approximately 47,000 pounds. Product can be mixed to fill truck, provided weight does not exceed limit.

† Lbs/Unit is approximate.

+ Rounded up to the nearest half-piece.

CertainTeed Product Codes for Ordering

The Finish, Style, Size and Color of a product is represented with an 8 digit Code System. Choose Product Code from the chart above.

Finish Code

10-FiberTect® Primer/Sealer

Product Code

Style, Size and Texture



Color Code

FiberTect® Primer/Sealer Code is 000

Trim

7/16" TRIM/FASCIA							
Sizes	FiberTect® Product Codes	Pieces/Unit	Sq. Ft./Unit	Lineal Ft./Unit	Lbs./Unit†	Units/Truck*	
3-1/2" x 12' Actual	10246/000	390	1,365	4,680	4,666	10	
5-1/2" x 12' Actual	10247/000	248	1,364	2,976	4,663	10	
7-1/4" x 12' Actual	10248/000	186	1,349	2,232	4,685	10	
9-1/4" x 12' Actual	10249/000	145	1,341	1,740	4,588	10	
11-1/4" x 12' Actual 7/16" thick	10250/000	120	1,350	1,440	4,617	10	

4/4 TRIM†							
Sizes	Primed Reversible-Wood Grain/Smooth Product Codes	Pieces/Unit	Sq. Ft./Unit	Lineal Ft./Unit	Lbs./Unit†	Units/Truck*	
2" x 12' Actual size: 3/4" x 1 3/4" x 12'	10264/000	506	885	6,072	3,978	12	
3" x 12' Actual size: 3/4" x 2 1/2" x 12'	10262/000	352	880	4,224	3,710	12	
4" x 12' Actual size: 3/4" x 3 1/2" x 12'	10252/000	250	875	3,000	3,845	12	
6" x 12' Actual size: 3/4" x 5 1/2" x 12'	10253/000	161	885	1,932	3,896	12	
8" x 12' Actual size: 3/4" x 7 1/4" x 12'	10254/000	115	833	1,380	3,674	12	
10" x 12' Actual size: 3/4" x 9 1/4" x 12'	10255/000	96	888	1,152	3,782	12	
12" x 12' Actual size: 3/4" x 11 1/4" x 12' 4/4 thick	10256/000	78	877	936	3,744	12	

5/4 TRIM†							
Sizes	Primed Reversible-Wood Grain/Smooth Product Codes	Pieces/Unit	Sq. Ft./Unit	Lineal Ft./Unit	Lbs./Unit†	Units/Truck*	
3" x 12' Actual size: 1" x 2 1/2" x 12'	10263/000	256	640	3,072	4,454	12	
4" x 12' Actual size: 1" x 3 1/2" x 12'	10257/000	190	665	2,280	3,838	12	
5" x 12' Actual size: 1" x 4 1/2" x 12'	10279/000	144	648	1,728	3,846	12	
6" x 12' Actual size: 1" x 5 1/2" x 12'	10258/000	119	655	1,428	3,654	12	
8" x 12' Actual size: 1" x 7 1/4" x 12'	10259/000	90	653	1,080	3,645	12	
10" x 12' Actual size: 1" x 9 1/4" x 12'	10260/000	68	629	816	3,522	12	
12" x 12' Actual size: 1" x 11 1/4" x 12' 5/4 thick	10261/000	57	641	684	3,695	12	

Finishing Touches

RESTORATION MILLWORK® SKIRTBOARD						
Sizes	DualStart™ – Wood Grain/Smooth Product Codes	CertaPak™ Pieces/Unit	Pieces/Full Unit	Lineal Ft./Full Unit	Lbs./Full Unit†	
1" x 6" x 12' Actual size: 3/4" x 5 1/2" x 12'	12350612005	4	64	768	608	
1" x 8" x 12' Actual size: 3/4" x 7 1/4" x 12'	12350812005	2	48	576	581	
5/4" x 6" x 12' Actual size: 1" x 5 1/2" x 12'	12360612005	4	64	768	760	
5/4" x 8" x 12' Actual size: 1" x 7 1/4" x 12'	12360812005	2	48	576	713	

Mixed Pallets						
Sizes	Product Codes	Pieces/Unit	Pieces/Full Unit	Lineal Ft./Full Unit	Lbs./Full Unit†	
1" x 6" x 12' Actual size: 3/4" x 5 1/2" x 12'	12355812005	4	32	672	745	
1" x 8" x 12' Actual size: 3/4" x 7 1/4" x 12'		2	24			
5/4" x 6" x 12' Actual size: 1" x 5 1/2" x 12'	12365812005	4	32	672	775	
5/4" x 8" x 12' Actual size: 1" x 7 1/4" x 12'		2	24			

Underlayment

UNDERLAYMENT (UNPRIMED)							
Sizes	FiberTect® Product Codes	Pieces/Unit	Sq. Ft./Unit	Sq. Cov./Unit	Lbs./Unit†	Units/Truck*	
3' x 5'	10200/000	85	1,275	12.8	2,449	18	
4' x 4'	10202/000	85	1,360	13.6	2,614	17	
4' x 8' 1/4" thick	10203/000	50	1,600	16	3,100	15	

Backerboard

BACKERBOARD (UNPRIMED)							
Sizes	FiberTect® Product Codes	Pieces/Unit	Sq. Ft./Unit	Sq. Cov./Unit	Lbs./Unit†	Units/Truck*	
3' x 5' 1/2" thick	10201/000	50	750	7.5	2,700	17	

† 4/4 and 5/4 Trim:

- Made expressly for CertainTeed by Plycem® and does not utilize FiberTect® Primer/Sealer.
- Available in the US and Canada except for the following states: AL, AR, FL, GA, LA, MS, OK, SC, TN, TX.

* Product weight per truck is limited to approximately 47,000 pounds. Product can be mixed to fill truck, provided weight does not exceed limit.

† Lbs/Unit is approximate.

CertainTeed Product Codes for Ordering

The Finish, Style, Size and Color of a product is represented with an 8 digit Code System. Choose Product Code from the chart above.

Finish Code

10-FiberTect® Primer/Sealer

Product Code



Style, Size and Texture



Color Code

FiberTect® Primer/Sealer Code is 000

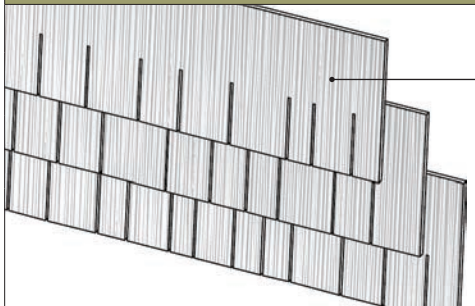
Shapes

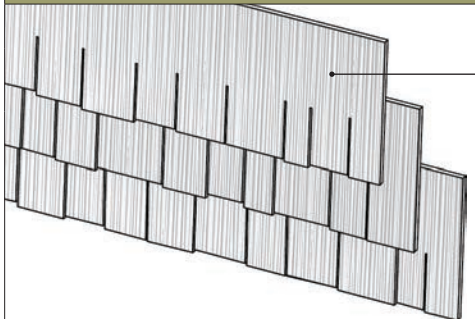
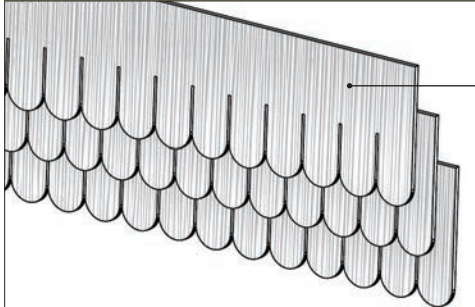
PERFECTION SHINGLES		Product Codes	Solid Colors	Stains	Full Unit					Half Unit (Not available)	Micro Unit				
Sizes	Pieces/Unit				Sq. Ft./Unit	Sq. Cov./Unit	Pieces/Sq. Cov.	Lbs./Unit†	Units/Truck*	Pieces/Unit	Sq. Ft./Unit	Sq. Cov./Unit	Pieces/Sq. Cov.	Lbs./Unit†	
 <p>8-1/4" X 12" (7" Exposure) 7/16" thick</p>	□□281□/□□□	■	●	160	1,320	11.2	14.5*	4,443	10		36	297	2.5	14.5*	1,000
RANDOM SQUARE STRAIGHT EDGE		Product Codes	Solid Colors	Stains	Full Unit					Half Unit (Not available)	Micro Unit				
Sizes	Pieces/Unit				Sq. Ft./Unit	Sq. Cov./Unit	Pieces/Sq. Cov.	Lbs./Unit†	Units/Truck*	Pieces/Unit	Sq. Ft./Unit	Sq. Cov./Unit	Pieces/Sq. Cov.	Lbs./Unit†	
 <p>12" x 48" (5" Exposure)</p>	15326□/□□□	■		120	480	2	60	1,260	38		60	240	1.0	60	650
 <p>16" x 48" (7" Exposure) 5/16" thick</p>	□□329□/□□□	■	●	129	688	3	43	1,780	27		45	240	1.1	43	650
RANDOM SQUARE STAGGERED EDGE		Product Codes	Solid Colors	Stains	Full Unit					Half Unit (Not available)	Micro Unit				
Sizes	Pieces/Unit				Sq. Ft./Unit	Sq. Cov./Unit	Pieces/Sq. Cov.	Lbs./Unit†	Units/Truck*	Pieces/Unit	Sq. Ft./Unit	Sq. Cov./Unit	Pieces/Sq. Cov.	Lbs./Unit†	
 <p>16" x 48" (7" Exposure) 5/16" thick</p>	□□330□/□□□	■	●	129	688	3	43	1,780	27		45	240	1.1	43	650
HALF-ROUNDS		Product Codes	Solid Colors	Stains	Full Unit					Half Unit (Not available)	Micro Unit				
Sizes	Pieces/Unit				Sq. Ft./Unit	Sq. Cov./Unit	Pieces/Sq. Cov.	Lbs./Unit†	Units/Truck*	Pieces/Unit	Sq. Ft./Unit	Sq. Cov./Unit	Pieces/Sq. Cov.	Lbs./Unit†	
 <p>16" x 48" (7" Exposure) 5/16" thick</p>	15331□/□□□	■		129	688	3	43	1,780	27		45	240	1.1	43	650

* Product weight per truck is limited to approximately 47,000 pounds. Product can be mixed to fill truck, provided weight does not exceed limit.

† Lbs/Unit is approximate. + Rounded up to the nearest half-piece.

CertainTeed Product Codes for Ordering

The Finish, Style, Size and Color of a product is represented with a 9 digit code system. To determine your product code, follow these 4 easy steps:

- Step 1: Choose the **Finish Code** for ■ Solid Colors (15) or ● Stains (14);
- Step 2: Choose the **Product Code** from the chart above;
- Step 3: Choose the **Color Code** from the list of ■ Solid Colors and ● Stains;
- Step 4: Choose the **Unit Size Code**. If ordering a **Full Unit**, no additional code is required. If ordering a **Half Unit** or a **Micro Unit**, add "H" or "M" after the first 5 digits of the Product Code.

Finish Code

- 15—ColorMax® Solid Colors
- 14—ColorMax® Stains

Product Code

Style, Size and Texture

Unit Size Code

Full unit, no additional code needed;
Half Unit, add 'H';
Micro Unit, add 'M'.



ColorMax® Finishing System—■ Solid Color Codes

 600 Vanilla White	 603 Butter	 606 Wicker	 609 Silverplate	 612 Desert Gold	 615 Autumn Red
 601 Antique White	 604 Merino Tan	 607 Newport Taupe	 610 Nantucket Gray	 613 Pewter	
 602 Linen	 605 Heritage Clay	 608 Heather	 611 Olive	 614 Coastal Blue	

ColorMax® Finishing System—● Stain Color Codes

 521 Mahogany	 522 Redwood	 523 Cedar	 524 Maple	 525 Slate	 526 Emerald
--	---	---	---	---	---

Colors shown are representative of finished product and are as accurate as printing methods permit.

Shapes

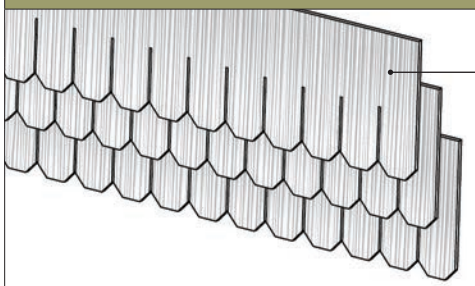
OCTAGONS		Product Codes	Solid Colors	Stains	Full Unit					Half Unit (Not available)						Micro Unit					
					Pieces/Unit	Sq. Ft./Unit	Sq. Cov./Unit	Pieces/Sq. Cov.	Lbs./Unit†	Units/Truck*	Pieces/Unit	Sq. Ft./Unit	Sq. Cov./Unit	Pieces/Sq. Cov.	Lbs./Unit†						
	Sizes 16" x 48" (7" Exposure) 5/16" thick	15337□/□□□	■		129	688	3	43	1,780	27							45	240	1.1	43	650

Lap Siding

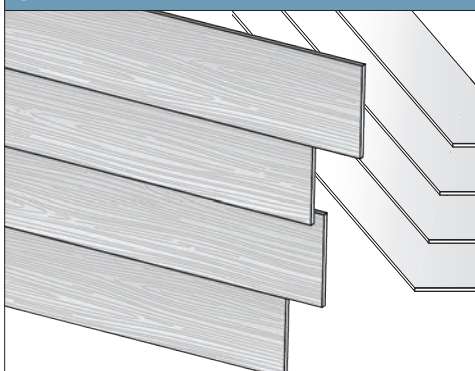
CEDAR LAP		Product Codes	Solid Colors	Stains	Full Unit					Half Unit						Micro Unit					
					Pieces/Unit	Sq. Ft./Unit	Sq. Cov./Unit	Pieces/Sq. Cov.	Lbs./Unit†	Units/Truck*	Pieces/Unit	Sq. Ft./Unit	Sq. Cov./Unit	Pieces/Sq. Cov.	Lbs./Unit†	Units/Truck*	Pieces/Unit	Sq. Ft./Unit	Sq. Cov./Unit	Pieces/Sq. Cov.	Lbs./Unit†
	Sizes 5-1/4" x 12' 5/16" thick	15063□/□□□	■		320	1,680	12.8	25	4,300	10	160	840	6.4	25	2,200	20	64	336	2.6	25	905
	6-1/4" x 12'	□□015□/□□□	■	●	280	1,750	14	20	4,475	10	140	875	7	20	2,288	20	48	300	2.4	20	805
	7-1/4" x 12'	□□016□/□□□	■	●	240	1,740	14.4	17+	4,450	10	120	870	7.2	17+	2,275	20	36	261	2.2	17+	718
	8-1/4" x 12'	□□017□/□□□	■	●	220	1,815	15.4	14.5+	4,683	10	100	825	7	14.5+	2,163	20	36	297	2.5	14.5+	808

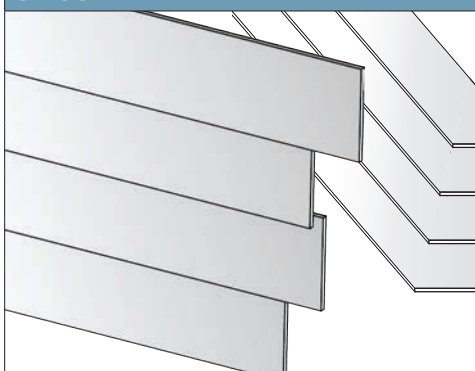
SMOOTH LAP		Product Codes	Solid Colors	Stains	Full Unit					Half Unit						Micro Unit					
					Pieces/Unit	Sq. Ft./Unit	Sq. Cov./Unit	Pieces/Sq. Cov.	Lbs./Unit†	Units/Truck*	Pieces/Unit	Sq. Ft./Unit	Sq. Cov./Unit	Pieces/Sq. Cov.	Lbs./Unit†	Units/Truck*	Pieces/Unit	Sq. Ft./Unit	Sq. Cov./Unit	Pieces/Sq. Cov.	Lbs./Unit†
	Sizes 5-1/4" x 12' 5/16" thick	15064□/□□□	■		320	1,680	12.8	25	4,300	10	160	840	6.4	25	2,200	20	64	336	2.6	25	905
	6-1/4" x 12'	15004□/□□□	■		280	1,750	14	20	4,475	10	140	875	7	20	2,288	20	48	300	2.4	20	805
	7-1/4" x 12'	15005□/□□□	■		240	1,740	14.4	17+	4,450	10	120	870	7.2	17+	2,275	20	36	261	2.2	17+	718
	8-1/4" x 12'	15074□/□□□	■		220	1,815	15.4	14.5+	4,683	10	100	825	7	14.5+	2,163	20	36	297	2.5	14.5+	808

* Product weight per truck is limited to approximately 47,000 pounds. Product can be mixed to fill truck, provided weight does not exceed limit.

† Lbs/Unit is approximate. + Rounded up to the nearest half-piece.

CertainTeed Product Codes for Ordering

The Finish, Style, Size and Color of a product is represented with a 9 digit code system. To determine your product code, follow these 4 easy steps:

- Step 1: Choose the **Finish Code** for ■ Solid Colors (15) or ● Stains (14);
- Step 2: Choose the **Product Code** from the chart above;
- Step 3: Choose the **Color Code** from the list of ■ Solid Colors and ● Stains;
- Step 4: Choose the **Unit Size Code**. If ordering a **Full Unit**, no additional code is required. If ordering a **Half Unit** or a **Micro Unit**, add "H" or "M" after the first 5 digits of the Product Code.

Finish Code

- 15—ColorMax® Solid Colors
- 14—ColorMax® Stains

Product Code

Style, Size and Texture

Unit Size Code

Full unit, no additional code needed;
 Half Unit, add 'H';
 Micro Unit, add 'M'.



ColorMax® Finishing System—■ Solid Color Codes



600 Vanilla White	603 Butter	606 Wicker	609 Silverplate	612 Desert Gold	615 Autumn Red
601 Antique White	604 Merino Tan	607 Newport Taupe	610 Nantucket Gray	613 Pewter	
602 Linen	605 Heritage Clay	608 Heather	611 Olive	614 Coastal Blue	

Colors shown are representative of finished product and are as accurate as printing methods permit.

ColorMax® Finishing System—● Stain Color Codes

521 Mahogany	522 Redwood	523 Cedar	524 Maple	525 Slate	526 Emerald
--------------	-------------	-----------	-----------	-----------	-------------

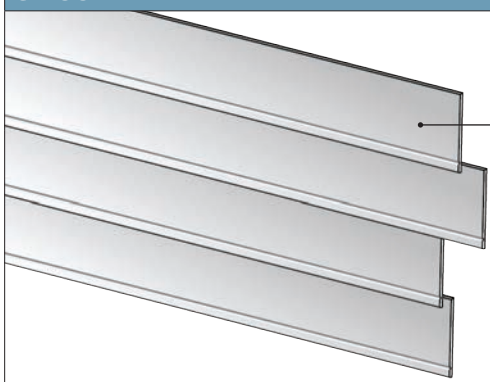
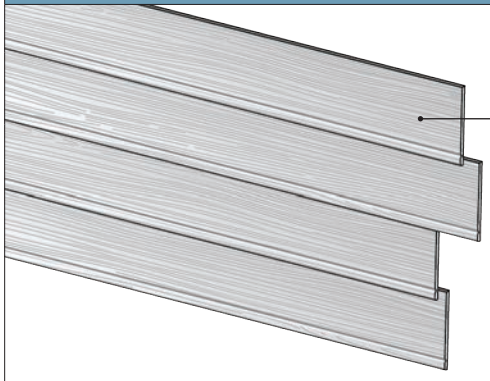
Lap Siding

SMOOTH BEADED																					
 Sizes 7-1/2" x 12" 5/16" thick	Product Codes	Solid Colors	Stains	Full Unit						Half Unit						Micro Unit					
				Pieces/Unit	Sq. Ft./Unit	Sq. Cov./Unit	Pieces/Sq. Cov.	Lbs./Unit‡	Units/Truck*	Pieces/Unit	Sq. Ft./Unit	Sq. Cov./Unit	Pieces/Sq. Cov.	Lbs./Unit‡	Units/Truck*	Pieces/Unit	Sq. Ft./Unit	Sq. Cov./Unit	Pieces/Sq. Cov.	Lbs./Unit‡	
	15021□/□□□	■		240	1,800	15	16	4,600	10	120	900	7.5	16	2,350	20	36	270	2.3	16	740	
TEXTURED BEADED																					
 Sizes 7-1/2" x 12" 5/16" thick	Product Codes	Solid Colors	Stains	Full Unit						Half Unit						Micro Unit					
				Pieces/Unit	Sq. Ft./Unit	Sq. Cov./Unit	Pieces/Sq. Cov.	Lbs./Unit‡	Units/Truck*	Pieces/Unit	Sq. Ft./Unit	Sq. Cov./Unit	Pieces/Sq. Cov.	Lbs./Unit‡	Units/Truck*	Pieces/Unit	Sq. Ft./Unit	Sq. Cov./Unit	Pieces/Sq. Cov.	Lbs./Unit‡	
	15023□/□□□	■		240	1,800	15	16	4,600	10	120	900	7.5	16	2,350	20	36	270	2.3	16	740	
TEXTURED DUTCHLAP																					
 Sizes 8-1/4" X 12" 5/16" thick	Product Codes	Solid Colors	Stains	Full Unit						Half Unit						Micro Unit					
				Pieces/Unit	Sq. Ft./Unit	Sq. Cov./Unit	Pieces/Sq. Cov.	Lbs./Unit‡	Units/Truck*	Pieces/Unit	Sq. Ft./Unit	Sq. Cov./Unit	Pieces/Sq. Cov.	Lbs./Unit‡	Units/Truck*	Pieces/Unit	Sq. Ft./Unit	Sq. Cov./Unit	Pieces/Sq. Cov.	Lbs./Unit‡	
	15525□/□□□	■		220	1,815	15.4	14.5+	4,683	10	100	825	7	14.5+	2,163	20	36	297	2.5	14.5+	808	

* Product weight per truck is limited to approximately 47,000 pounds. Product can be mixed to fill truck, provided weight does not exceed limit.

‡ Lbs/Unit is approximate.
+ Rounded up to the nearest half-piece.

CertainTeed Product Codes for Ordering

The Finish, Style, Size and Color of a product is represented with a 9 digit code system. To determine your product code, follow these 4 easy steps:

- Step 1: Choose the **Finish Code** for ■ Solid Colors (15);
- Step 2: Choose the **Product Code** from the chart above;
- Step 3: Choose the **Color Code** from the list of ■ Solid Colors;
- Step 4: Choose the **Unit Size Code**. If ordering a **Full Unit**, no additional code is required. If ordering a **Half Unit** or a **Micro Unit**, add "H" or "M" after the first 5 digits of the Product Code.

Finish Code

■ 15—ColorMax® Solid Colors



Product Code

Style, Size and Texture

Unit Size Code

Full unit, no additional code needed;
Half Unit, add 'H';
Micro Unit, add 'M'.

ColorMax® Finishing System—■ Solid Color Codes

	600 Vanilla White		603 Butter		606 Wicker		609 Silverplate		612 Desert Gold		615 Autumn Red
	601 Antique White		604 Merino Tan		607 Newport Taupe		610 Nantucket Gray		613 Pewter		
	602 Linen		605 Heritage Clay		608 Heather		611 Olive		614 Coastal Blue		

Colors shown are representative of finished product and are as accurate as printing methods permit.

Vertical Siding

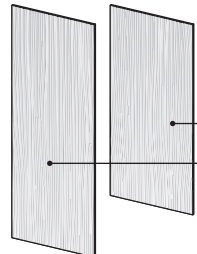
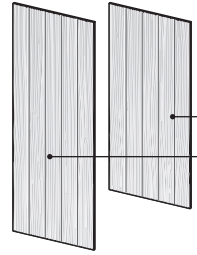
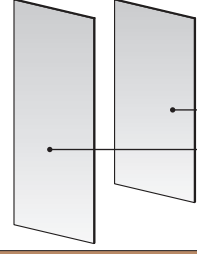
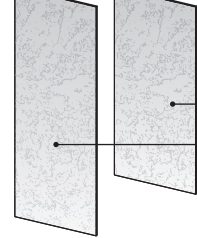
CEDAR NO GROOVE																	
 Sizes 4' x 8' 4' x 10' 5/16" thick	Product Codes	Solid Colors	Stains	Full Unit							Half Unit						Micro Unit (Not available)
				Pieces/Unit	Sq. Ft./Unit	Sq. Cov./Unit	Pieces/Sq. Cov.	Lbs./Unit‡	Units/Truck*	Pieces/Unit	Sq. Ft./Unit	Sq. Cov./Unit	Pieces/Sq. Cov.	Lbs./Unit‡	Units/Truck*		
	15041□/□□□	■		50	1,600	16	3.1	4,100	11	25	800	8	1.6	2,050	22		
	15043□/□□□	■		50	2,000	20	2.5	5,100	9	25	1,000	10	1.3	2,550	18		
CEDAR 8" GROOVE																	
 Sizes 4' x 8' 4' x 10' 5/16" thick	Product Codes	Solid Colors	Stains	Full Unit							Half Unit						Micro Unit (Not available)
				Pieces/Unit	Sq. Ft./Unit	Sq. Cov./Unit	Pieces/Sq. Cov.	Lbs./Unit‡	Units/Truck*	Pieces/Unit	Sq. Ft./Unit	Sq. Cov./Unit	Pieces/Sq. Cov.	Lbs./Unit‡	Units/Truck*		
	15035□/□□□	■		50	1,600	16	3.1	4,100	11	25	800	8	1.6	2,050	22		
	15037□/□□□	■		50	2,000	20	2.5	5,100	9	25	1,000	10	1.3	2,550	18		
SMOOTH																	
 Sizes 4' x 8' 4' x 10' 5/16" thick	Product Codes	Solid Colors	Stains	Full Unit							Half Unit						Micro Unit (Not available)
				Pieces/Unit	Sq. Ft./Unit	Sq. Cov./Unit	Pieces/Sq. Cov.	Lbs./Unit‡	Units/Truck*	Pieces/Unit	Sq. Ft./Unit	Sq. Cov./Unit	Pieces/Sq. Cov.	Lbs./Unit‡	Units/Truck*		
	15029□/□□□	■		50	1,600	16	3.1	4,100	11	25	800	8	1.6	2,050	22		
	15031□/□□□	■		50	2,000	20	2.5	5,100	9	25	1,000	10	1.3	2,550	18		
STUCCO																	
 Sizes 4' x 8' 4' x 10' 5/16" thick	Product Codes	Solid Colors	Stains	Full Unit							Half Unit						Micro Unit (Not available)
				Pieces/Unit	Sq. Ft./Unit	Sq. Cov./Unit	Pieces/Sq. Cov.	Lbs./Unit‡	Units/Truck*	Pieces/Unit	Sq. Ft./Unit	Sq. Cov./Unit	Pieces/Sq. Cov.	Lbs./Unit‡	Units/Truck*		
	15047□/□□□	■		50	1,600	16	3.1	4,100	11	25	800	8	1.6	2,050	22		
	15049□/□□□	■		50	2,000	20	2.5	5,100	9	25	1,000	10	1.3	2,550	18		

* Product weight per truck is limited to approximately 47,000 pounds. Product can be mixed to fill truck, provided weight does not exceed limit.

‡ Lbs/Unit is approximate. + Rounded up to the nearest half-piece.

CertainTeed Product Codes for Ordering

The Finish, Style, Size and Color of a product is represented with a 9 digit code system. To determine your product code, follow these 4 easy steps:

- Step 1: Choose the **Finish Code** for ■ Solid Colors (15) or ● Stains (14);
- Step 2: Choose the **Product Code** from the chart above;
- Step 3: Choose the **Color Code** from the list of ■ Solid Colors and ● Stains;
- Step 4: Choose the **Unit Size Code**. If ordering a **Full Unit**, no additional code is required. If ordering a **Half Unit** or a **Micro Unit**, add "H" or "M" after the first 5 digits of the Product Code.

Finish Code

- 15—ColorMax® Solid Colors
- 14—ColorMax® Stains

Product Code

Style, Size and Texture

Unit Size Code

Full unit, no additional code needed;
 Half Unit, add 'H';
 Micro Unit, add 'M'.



ColorMax® Finishing System—■ Solid Color Codes

 600 Vanilla White	 603 Butter	 606 Wicker	 609 Silverplate	 612 Desert Gold	 615 Autumn Red
 601 Antique White	 604 Merino Tan	 607 Newport Taupe	 610 Nantucket Gray	 613 Pewter	
 602 Linen	 605 Heritage Clay	 608 Heather	 611 Olive	 614 Coastal Blue	

ColorMax® Finishing System—● Stain Color Codes

 521 Mahogany	 522 Redwood	 523 Cedar	 524 Maple	 525 Slate	 526 Emerald
--	---	---	---	---	---

Colors shown are representative of finished product and are as accurate as printing methods permit.

Porch Ceiling Panel

CEDAR																
Image	Sizes	Product Codes	Solid Colors	Stains	Full Unit						Half Unit (Not available)	Micro Unit				
					Pieces/Unit	Sq. Ft./Unit	Sq. Cov./Unit	Pieces/Sq. Cov.	Lbs./Unit†	Units/Truck*	Pieces/Unit	Sq. Ft./Unit	Sq. Cov./Unit	Pieces/Sq. Cov.	Lbs./Unit†	
	4' x 8' 1/4" thick	15122□/□□□	■		50	1,600	16	3.1	3,450	10		12	384	3.8	3.1	887
SMOOTH																
Image	Sizes	Product Codes	Solid Colors	Stains	Full Unit						Half Unit (Not available)	Micro Unit				
					Pieces/Unit	Sq. Ft./Unit	Sq. Cov./Unit	Pieces/Sq. Cov.	Lbs./Unit†	Units/Truck*	Pieces/Unit	Sq. Ft./Unit	Sq. Cov./Unit	Pieces/Sq. Cov.	Lbs./Unit†	
	4' x 8' 1/4" thick	15121□/□□□	■		50	1,600	16	3.1	3,450	10		12	384	3.8	3.1	887

Soffit

CEDAR																
Image	Sizes	Product Codes	Solid Colors	Stains	Full Unit						Half Unit (Not available)	Micro Unit				
					Pieces/Unit	Sq. Ft./Unit	Sq. Cov./Unit	Pieces/Sq. Cov.	Lbs./Unit†	Units/Truck*	Pieces/Unit	Sq. Ft./Unit	Sq. Cov./Unit	Pieces/Sq. Cov.	Lbs./Unit†	
	12" x 12'	□□019□/□□□	■	●	188	2,256	22.6	8.5*	4,925	10		16	192	1.9	8.5*	415
	16" x 12'	□□060□/□□□	■	●	141	2,256	22.6	6.5*	4,925	10		14	224	2.2	6.5*	463
	24" x 12' 1/4" thick	□□062□/□□□	■	●	94	2,256	22.6	4.5*	4,925	10		12	288	2.9	4.5*	590
CEDAR VENTILATED/PERFORATED																
Image	Sizes	Product Codes	Solid Colors	Stains	Full Unit						Half Unit (Not available)	Micro Unit				
					Pieces/Unit	Sq. Ft./Unit	Sq. Cov./Unit	Pieces/Sq. Cov.	Lbs./Unit†	Units/Truck*	Pieces/Unit	Sq. Ft./Unit	Sq. Cov./Unit	Pieces/Sq. Cov.	Lbs./Unit†	
	12" x 12'	□□266□/□□□	■	●	188	2,256	22.6	8.5*	4,925	10		16	192	1.9	8.5*	415
	16" x 12'	□□268□/□□□	■	●	141	2,256	22.6	6.5*	4,925	10		14	224	2.2	6.5*	463
	24" x 12' 1/4" thick	□□270□/□□□	■	●	94	2,256	22.6	4.5*	4,925	10		12	288	2.9	4.5*	590

* Product weight per truck is limited to approximately 47,000 pounds. Product can be mixed to fill truck, provided weight does not exceed limit.

† Lbs/Unit is approximate. + Rounded up to the nearest half-piece.

CertainTeed Product Codes for Ordering

The Finish, Style, Size and Color of a product is represented with a 9 digit code system. To determine your product code, follow these 4 easy steps:

- Step 1: Choose the **Finish Code** for ■ Solid Colors (15) or ● Stains (14);
- Step 2: Choose the **Product Code** from the chart above;
- Step 3: Choose the **Color Code** from the list of ■ Solid Colors and ● Stains;
- Step 4: Choose the **Unit Size Code**. If ordering a **Full Unit**, no additional code is required. If ordering a **Half Unit** or a **Micro Unit**, add "H" or "M" after the first 5 digits of the Product Code.

Finish Code

- 15—ColorMax® Solid Colors
- 14—ColorMax® Stains

Product Code

Style, Size and Texture

Unit Size Code

Full unit, no additional code needed;
Half Unit, add 'H';
Micro Unit, add 'M'.



ColorMax® Finishing System—■ Solid Color Codes

600 Vanilla White	603 Butter	606 Wicker	609 Silverplate	612 Desert Gold	615 Autumn Red
601 Antique White	604 Merino Tan	607 Newport Taupe	610 Nantucket Gray	613 Pewter	
602 Linen	605 Heritage Clay	608 Heather	611 Olive	614 Coastal Blue	

Colors shown are representative of finished product and are as accurate as printing methods permit.

ColorMax® Finishing System—● Stain Color Codes

521 Mahogany	522 Redwood	523 Cedar	524 Maple	525 Slate	526 Emerald
--------------	-------------	-----------	-----------	-----------	-------------

Soffit

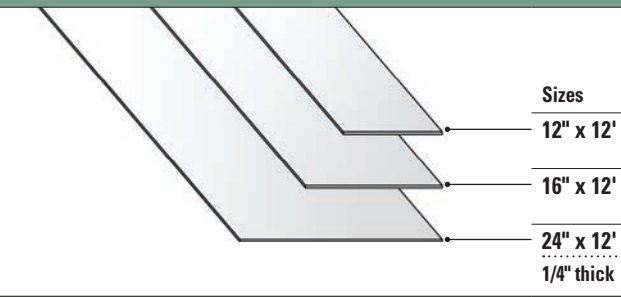
SMOOTH																
 Sizes 12" x 12' 16" x 12' 24" x 12' 1/4" thick	Product Codes	Solid Colors	Stains	Full Unit					Half Unit (Not available)			Micro Unit				
				Pieces/Unit	Sq. Ft./Unit	Sq. Cov./Unit	Pieces/Sq. Cov.	Lbs./Unit‡	Units/Truck*	Pieces/Unit	Sq. Ft./Unit	Sq. Cov./Unit	Pieces/Sq. Cov.	Lbs./Unit‡		
	15007□/□□□	■		188	2,256	22.6	8.5+	4,925	10			16	192	1.9	8.5+	415
	15335□/□□□	■		141	2,256	22.6	6.5+	4,925	10			14	224	2.2	6.5+	463
	15340□/□□□	■		94	2,256	22.6	4.5+	4,925	10			12	288	2.9	4.5+	590

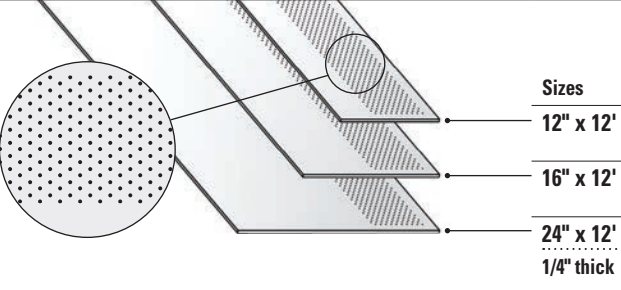
SMOOTH VENTILATED/PERFORATED																
 Sizes 12" x 12' 16" x 12' 24" x 12' 1/4" thick	Product Codes	Solid Colors	Stains	Full Unit					Half Unit (Not available)			Micro Unit				
				Pieces/Unit	Sq. Ft./Unit	Sq. Cov./Unit	Pieces/Sq. Cov.	Lbs./Unit‡	Units/Truck*	Pieces/Unit	Sq. Ft./Unit	Sq. Cov./Unit	Pieces/Sq. Cov.	Lbs./Unit‡		
	15267□/□□□	■		188	2,256	22.6	8.5+	4,925	10			16	192	1.9	8.5+	415
	15269□/□□□	■		141	2,256	22.6	6.5+	4,925	10			14	224	2.2	6.5+	463
	15271□/□□□	■		94	2,256	22.6	4.5+	4,925	10			12	288	2.9	4.5+	590

* Product weight per truck is limited to approximately 47,000 pounds. Product can be mixed to fill truck, provided weight does not exceed limit.

‡ Lbs/Unit is approximate.
+ Rounded up to the nearest half-piece.

CertainTeed Product Codes for Ordering

The Finish, Style, Size and Color of a product is represented with a 9 digit code system. To determine your product code, follow these 4 easy steps:

- Step 1: Choose the **Finish Code** for ■ Solid Colors (15);
- Step 2: Choose the **Product Code** from the chart above;
- Step 3: Choose the **Color Code** from the list of ■ Solid Colors;
- Step 4: Choose the **Unit Size Code**. If ordering a **Full Unit**, no additional code is required. If ordering a **Half Unit** or a **Micro Unit**, add "H" or "M" after the first 5 digits of the Product Code.

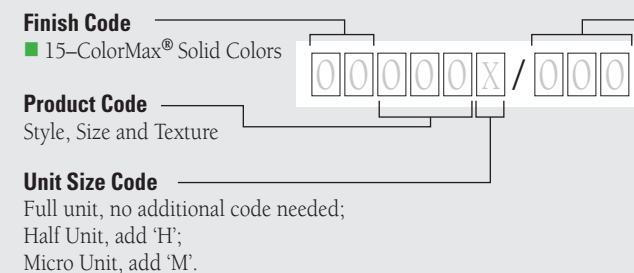











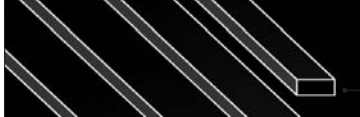

ColorMax® Finishing System—■ Solid Color Codes

	600 Vanilla White		603 Butter		606 Wicker		609 Silverplate		612 Desert Gold		615 Autumn Red
	601 Antique White		604 Merino Tan		607 Newport Taupe		610 Nantucket Gray		613 Pewter		
	602 Linen		605 Heritage Clay		608 Heather		611 Olive		614 Coastal Blue		

Colors shown are representative of finished product and are as accurate as printing methods permit.

Trim

4/4 TRIM†							Full Unit					Half Unit (Not available)				Micro Unit			
	Wood Grain Product Codes	Solid Colors	Stains	Smooth Product Codes	Solid Colors	Stains	Pieces/Unit	Sq. Ft./Unit	Lineal Ft./Unit	Lbs./Unit‡	Units/Truck*					Pieces/Unit	Sq. Ft./Unit	Lineal Ft./Unit	Lbs./Unit‡
 2" x 12' Actual size: ¾" x 1¾" x 12'	15264□/□□□	■		15265□/□□□	■		462	808	5,544	3,605	12				18	31	216	116	
 3" x 12' Actual size: ¾" x 2½" x 12'	15262□/□□□	■		15272□/□□□	■		330	825	3,960	3,632	12				18	45	216	244	
 4" x 12' Actual size: ¾" x 3½" x 12'	15252□/□□□	■		15418□/□□□	■		240	840	2,880	3,698	12				18	63	216	330	
 6" x 12' Actual size: ¾" x 5½" x 12'	15253□/□□□	■		15419□/□□□	■		147	808	1,764	3,564	12				16	88	192	435	
 8" x 12' Actual size: ¾" x 7¼" x 12'	15254□/□□□	■		15420□/□□□	■		115	833	1,380	3,674	12				15	108	180	522	
 10" x 12' Actual size: ¾" x 9¼" x 12'	15255□/□□□	■		15421□/□□□	■		88	814	1,056	3,594	12				12	111	144	522	
 12" x 12' Actual size: ¾" x 11¼" x 12' 4/4 thick	15256□/□□□	■		15422□/□□□	■		72	810	864	3,568	12				12	135	144	632	

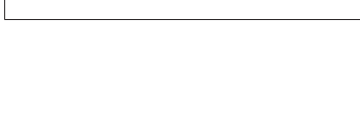
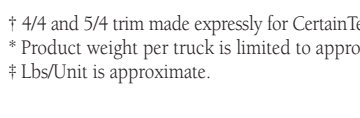
5/4 TRIM†							Full Unit					Half Unit (Not available)				Micro Unit			
	Wood Grain Product Codes	Solid Colors	Stains	Smooth Product Codes	Solid Colors	Stains	Pieces/Unit	Sq. Ft./Unit	Lineal Ft./Unit	Lbs./Unit‡	Units/Truck*					Pieces/Unit	Sq. Ft./Unit	Lineal Ft./Unit	Lbs./Unit‡
 3" x 12' Actual size: 1" x 2½" x 12'	15263□/□□□	■		15123□/□□□	■		192	480	2,304	3,345	12				18	45	216	252	
 4" x 12' Actual size: 1" x 3½" x 12'	□□257□/□□□	■	●	15423□/□□□	■		180	630	2,160	3,692	12				18	63	216	418	
 5" x 12' Actual size: 1" x 4½" x 12'	15285□/□□□	■		15279□/□□□	■		144	648	1,728	3,846	12				15	67	180	393	
 6" x 12' Actual size: 1" x 5½" x 12'	□□258□/□□□	■	●	15424□/□□□	■		112	616	1,344	3,628	12				16	88	192	558	
 8" x 12' Actual size: 1" x 7¼" x 12'	15259□/□□□	■		15425□/□□□	■		85	616	1,020	3,621	12				15	108	180	674	
 10" x 12' Actual size: 1" x 9¼" x 12'	15260□/□□□	■		15426□/□□□	■		68	629	816	3,702	12				12	111	144	677	
 12" x 12' Actual size: 1" x 11¼" x 12' 5/4 thick	15261□/□□□	■		15427□/□□□	■		54	607	648	3,572	12				12	135	144	821	

† 4/4 and 5/4 trim made expressly for CertainTeed by Plycem®.

* Product weight per truck is limited to approximately 47,000 pounds. Product can be mixed to fill truck, provided weight does not exceed limit.

‡ Lbs/Unit is approximate.

CertainTeed Product Codes for Ordering

The Finish, Style, Size and Color of a product is represented with a 9 digit code system. To determine your product code, follow these 4 easy steps:

Step 1: Choose the Finish Code for ■ Solid Colors (15) or ● Stains (14);

Step 2: Choose the Product Code from the chart above;

Step 3: Choose the Color Code from the list of ■ Solid Colors and ● Stains;

Step 4: Choose the Unit Size Code. If ordering a Full Unit, no additional code is required. If ordering a Half Unit or a Micro Unit, add "H" or "M" after the first 5 digits of the Product Code.

Finish Code

- 15-ColorMax® Solid Colors
- 14-ColorMax® Stains

Product Code

Style, Size and Texture

Unit Size Code

Full unit, no additional code needed;
Half Unit, add 'H';
Micro Unit, add 'M'.

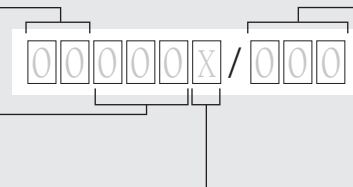







ColorMax® Finishing System—■ Solid Color Codes

 600 Vanilla White	 602 Linen	 605 Heritage Clay	 607 Newport Taupe	 611 Olive
 601 Antique White	 604 Merino Tan	 606 Wicker	 608 Heather	 614 Coastal Blue

Colors shown are representative of finished product and are as accurate as printing methods permit.

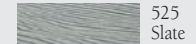
ColorMax® Finishing System—● Stain Color Codes

 521 Mahogany	 522 Redwood	 523 Cedar	 524 Maple	 525 Slate	 526 Emerald
--	---	---	---	---	---

Solid Colors Touch-Up Kit

Touch-Up Kit contains: (1) Quart can of paint (1) 4 oz. blotter (1) Pencil applicator (2) Paper funnels Instruction sheet		Touch-Up Kit Product Code
		15276/□□□

Stains Touch-Up Kit

Touch-Up Kit contains: (1) Quart can of stain (1) 1" foam brush Instruction sheet		Touch-Up Kit Product Code
		14405/□□□

* Product weight per truck is limited to approximately 47,000 pounds.
 Product can be mixed to fill truck, provided weight does not exceed limit.

‡ Lbs/Unit is approximate.
 + Rounded up to the nearest half-piece.

CertainTeed Product Codes for Ordering

The Finish, Style, Size and Color of a product is represented with a 9 digit code system. To determine your product code, follow these 4 easy steps:

- Step 1: Choose the **Finish Code** for ■ Solid Colors (15) or ● Stains (14);
- Step 2: Choose the **Product Code** from the chart above;
- Step 3: Choose the **Color Code** from the list of ■ Solid Colors and ● Stains;
- Step 4: Choose the **Unit Size Code**. If ordering a **Full Unit**, no additional code is required.
 If ordering a **Half Unit** or a **Micro Unit**, add "H" or "M" after the first 5 digits of the Product Code.

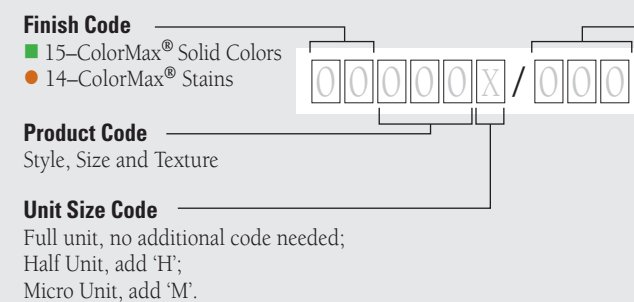

ColorMax® Finishing System—■ Solid Color Codes

 600 Vanilla White	 603 Butter	 606 Wicker	 609 Silverplate	 612 Desert Gold	 615 Autumn Red
 601 Antique White	 604 Merino Tan	 607 Newport Taupe	 610 Nantucket Gray	 613 Pewter	
 602 Linen	 605 Heritage Clay	 608 Heather	 611 Olive	 614 Coastal Blue	

Colors shown are representative of finished product and are as accurate as printing methods permit.

ColorMax® Finishing System—● Stain Color Codes

 521 Mahogany	 522 Redwood	 523 Cedar	 524 Maple	 525 Slate	 526 Emerald
---	--	--	--	--	--



CertainTeed products are designed to work together and complement each other in color and style to give your home a beautiful finished look.



Polymer Shakes & Shingles



Fiber Cement Siding



Fence



Insulated Siding



PVC Exterior Trim & Beadboard



Decking and Railing



Vinyl Siding



Vinyl Carpentry® Trim



Housewrap

buildingresponsibly™

ASK ABOUT OUR OTHER CERTAINTEED® PRODUCTS AND SYSTEMS:

EXTERIOR: ROOFING • SIDING • WINDOWS • FENCE • RAILING • TRIM • DECKING • FOUNDATIONS • PIPE

INTERIOR: INSULATION • GYPSUM • CEILINGS

CertainTeed Corporation
P.O. Box 860
Valley Forge, PA 19482

Professional: 800-233-8990
Consumer: 800-782-8777
www.certainteed.com

CertainTeed 